

# 1-800-BOLLARDS



The Bollard Experts

- SELECT DESIRED MATERIAL:  
(4" NOMINAL SIZE)
- BSS04000 SCH 10 STAINLESS STEEL
  - BSS04040 SCH 40 STAINLESS STEEL
  - BSS04080 SCH 80 STAINLESS STEEL
  - BCS04040 SCH 40 ASTM A-53 CARBON STEEL
  - BCS04080 SCH 80 ASTM A-53 CARBON STEEL

- SELECT DESIRED STAINLESS STEEL BOLLARD FINISH:
- POLISHED #4 FINISH
  - AS SPECIFIED \_\_\_\_\_

- SELECT DESIRED CARBON STEEL BOLLARD FINISH:
- POWDER COAT RAL # \_\_\_\_\_
  - AS SPECIFIED \_\_\_\_\_

- SELECT DESIRED STAINLESS STEEL BOLLARD MATERIAL:
- TYPE 304
  - TYPE 316

- SELECT DESIRED BOLLARD CAP STYLE:
-  DOME
  -  FLAT
  -  SLOPED

- LENS SELECTION
- CLEAR
  - FROSTED
  - INTERNAL FROSTED
  - PARACLINE SILVER
  - PARACLINE WHITE

- WATTAGE
- 5W 16LEDS 100mA
  - 8W 16LEDS 175mA
  - 12W 16LEDS 250mA

- CCT
- COOL
  - NEUTRAL
  - WARM

- VOLTAGE
- 120-277VAC
  - 120V

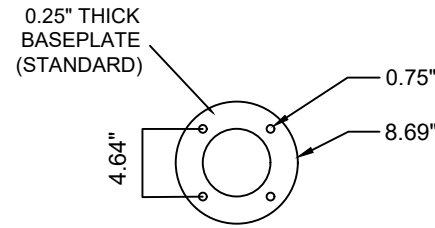
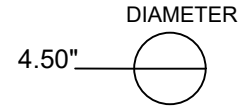
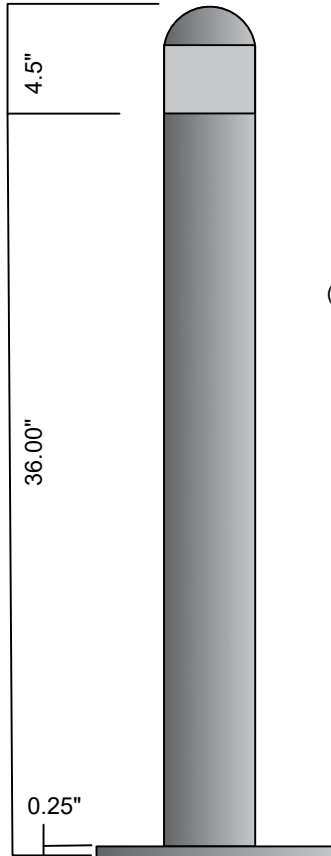
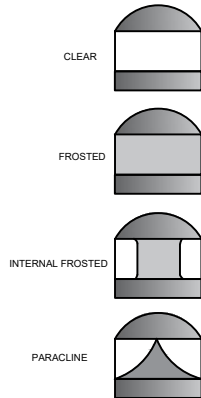

PLAN VIEW - BASE PLATE  
(USED ON STAINLESS STEEL BOLLARD)

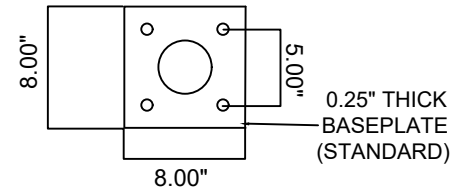

PLAN VIEW - BASE PLATE  
(USED ON CARBON STEEL BOLLARD)

ALTERNATE INSTALL METHOD

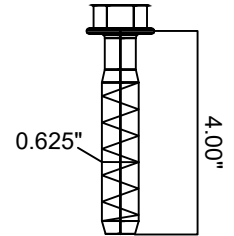

BASE PLATE REQUIRES  
(4) 0.625"X 4" ANCHOR BOLTS  
OR CINCH ANCHORS  
BY OTHERS

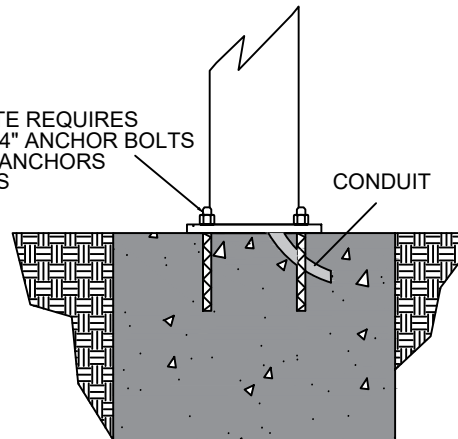

END VIEW - FOUNDATION

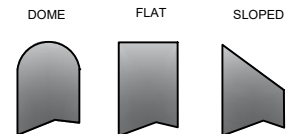

REVISIONS			
LTR	DESCRIPTION	DATE	APPVD

COMMENTS

**SPECIFICATIONS**

HEIGHT: 36"  
DIAMETER: 4.50"  
WALL THICKNESS: 0.280"

NOTES:  
1. INSTALLATION TO BE COMPLETED IN ACCORDANCE WITH MANUFACTURER'S SPECIFICATIONS.  
2. DO NOT SCALE DRAWING.  
3. THIS DRAWING IS INTENDED FOR USE BY ARCHITECTS, ENGINEERS, CONTRACTORS, CONSULTANTS AND DESIGN PROFESSIONALS FOR PLANNING PURPOSES ONLY. THIS DRAWING  
4. ALL INFORMATION CONTAINED HEREIN WAS CURRENT AT THE TIME OF DEVELOPMENT BUT MUST BE REVIEWED AND APPROVED BY THE PRODUCT MANUFACTURER TO BE CONSIDERED ACCURATE.

APPLICATION	
NEXT ASSY	USED ON

SERIES NUMBER: LB4000	CAGE CODE: LB4	REV: 4	DRAWING NUMBER: LB40
PRODUCT FAMILY: FIXED BOLLARD	STANDARD OR CUSTOMER DEFINED	DRAWN BY: AJA	DRAWING REV: 1
PRODUCT CLASS: BOLLARD	PRODUCT LINE: BASEPLATE	CHECKED BY:	SHEET: 1 OF 1
1-800-BOLLARDS, Inc. 10 Hughes Suite A105 Irvine, CA 92618 PHONE: 1-800-BOLLARDS WEB: WWW.1800BOLLARDS.COM EMAIL: INFO@1800BOLLARDS.COM		APPROVED BY:	RELEASE DATE: 1-11-2023
TITLE: BOLLARD, BASEPLATE			